

Dry Vacuum Pump nXDS Scroll Pump

INSTRUCTION MANUAL



edwardsvacuum.com



DESCRIPTION	ITEM NUMBER	DESCRIPTION	ITEM NUMBER
nXDS6i	A73501983	nXDS15iC	A73702983
nXDS10i	A73601983	nXDS20iC	A73802983
nXDS15i	A73701983	nXDS6iR	A73503983
nXDS20i	A73801983	nXDS10iR	A73603983
nXDS6iC	A73502983	nXDS15iR	A73703983
nXDS10iC	A73602983	nXDS20iR	A73803983

Copyright notice

©Edwards Limited 2020. All rights reserved.

Associated publications

Publication title	Publication number
Vacuum Pump and Vacuum System Safety	P40040100
nXDS Serial Comms Interface Instruction Manual	A73501860

Trademark credit

Edwards and the Edwards logo are trademarks of Edwards Limited, Innovation Drive, Burgess Hill, West Sussex RH15 9TW.

Disclaimer

The content of this manual may change from time to time without notice. We accept no liability for any errors that may appear in this manual nor do we make any expressed or implied warranties regarding the content. As far as practical we have ensured that the products have been designed and constructed to be safe and without risks when properly installed and used in accordance with their operating instructions.

We accept no liability for loss of profit, loss of market or any other indirect or consequential loss whatsoever.

Product warranty and limit of liability are dealt with in our standard terms and conditions of sale or negotiated contract under which this document is supplied.

You must use this product as described in this manual. Read the manual before you install, operate, or maintain the product.

CE Declaration of Conformity

Edwards Ltd
Innovation Drive
Burgess Hill
West Sussex
RH15 9TW
UK

The following product		
nXDS6i scroll pump	100-127/200-240V, 50/60Hz	A735-01-983
nXDS10i scroll pump	100-127/200-240V, 50/60Hz	A736-01-983
nXDS15i scroll pump	100-127/200-240V, 50/60Hz	A737-01-983
nXDS20i scroll pump	100-127/200-240V, 50/60Hz	A738-01-983
nXDS6iC scroll pump	100-127/200-240V, 50/60Hz	A735-02-983
nXDS10iC scroll pump	100-127/200-240V, 50/60Hz	A736-02-983
nXDS15iC scroll pump	100-127/200-240V, 50/60Hz	A737-02-983
nXDS20iC scroll pump	100-127/200-240V, 50/60Hz	A738-02-983
nXDS6iR scroll pump	100-127/200-240V, 50/60Hz	A735-03-983
nXDS10iR scroll pump	100-127/200-240V, 50/60Hz	A736-03-983
nXDS15iR scroll pump	100-127/200-240V, 50/60Hz	A737-03-983
nXDS20iR scroll pump	100-127/200-240V, 50/60Hz	A738-03-983

II Internal 3 G Ex h IIB T4 Gc

Is in conformity with the relevant requirements of European CE legislation:

2006/42/EC	Machinery directive
2014/34/EU	ATEX directive on use in potentially explosive atmospheres
2014/30/EU	Electromagnetic compatibility (EMC) directive
2011/65/EU	Restriction of certain hazardous substances (RoHS) directive as amended by Delegated Directive (EU) 2015/863

Based on the relevant requirements of harmonised standards:

EN 1012-2:1996 +A1:2009	Compressors and vacuum pumps. Safety requirements. Vacuum pumps
EN ISO 80079-36:2016	Explosive atmospheres – Part 36: Non-electrical equipment for explosive atmospheres. Basic method and requirements
EN ISO 80079-37:2016	Explosive atmospheres - Part 37: Non-electrical equipment for explosive atmospheres -- Non-electrical type of protection constructional safety "c", control of ignition sources "b", liquid immersion "k"
EN 61326-1:2013	Electrical equipment for measurement, control and laboratory use. EMC requirements. General requirements Class A Emissions Industrial Immunity

Documentation Officer: Jelena Havelkova, Spielberg Office Centre, Holandska 10, Brno, 63900 Czech Republic,
☎: +42(0) 734 418 896, ✉: documentation@edwardsvacuum.com

This declaration, based on the requirements of the listed Directives and EN ISO/IEC 17050-1, covers all product serial numbers from this date on: 30th October 2019.

Petr Smerek – Engineering Manager
Scientific Vacuum Division
Lutin

Ian Keech – General Manager
Product Company
Lutin

Additional Legislation and Compliance Information

EU EMC Directive: Class A/B Industrial equipment

Caution: This equipment is not intended for use in residential environments and may not provide adequate protection to radio reception in such environments.

EU RoHS Directive: Material Exemption Information

This product is compliant with the following Annex III Exemptions

- 6(b) **Lead** as an alloying element in aluminium containing up to 0.4% by weight
- 6(c) Copper alloy containing up to 4% **lead** by weight

EU REACH Regulation Compliance

This product is a complex article which is not designed for intentional substance release. To the best of our knowledge the materials used comply with the requirements of REACH. The product manual provides information and instruction to ensure the safe storage, use, maintenance and disposal of the product including any substance based requirements.

Article 33.1 Declaration

This product does contain Candidate List Substances of Very High Concern above 0.1%ww by article as clarified under the 2015 European Court of Justice ruling in case C-106/14.

- Lead (Pb) added to the Candidate List June 2018

As indicated by the applied RoHS exemption(s) above this substance is present in certain aluminium and brass components.

ADDITIONAL INFORMATION

The products listed are also in scope for and comply with the requirements of the following:

2012/19/EU Directive on waste electrical and electronic equipment (WEEE)

Product is certified to CSA-C22.2 No.61010-1-12 Safety requirements for electrical equipment for measurement, control and laboratory use – Part 1: General requirements

Product conforms to UL61010-1 3rd Edition Safety requirements for electrical equipment for measurement, control and laboratory use – Part 1: General requirements

材料成分声明

China Material Content Declaration

部件名称 Part name	有害物质 Hazardous Substances					
	铅 Lead (Pb)	汞 Mercury (Hg)	镉 Cadmium (Cd)	六价铬 Hexavalent Chromium (Cr VI)	多溴联苯 Polybrominated biphenyls (PBB)	多溴二苯醚 Polybrominated diphenyl ethers (PBDE)
铸铝及铝合金制品 Aluminium alloys	X	O	O	O	O	O
铜管管件 Brass pipe fitting	X	O	O	O	O	O
铜接头 Brass connectors	X	O	O	O	O	O

O: 表示该有害物质在该部件的所有均质材料中的含量低于 GB/T 26572 标准规定的限量要求。

O: Indicates that the hazardous substance contained in all of the homogeneous materials for this part is below the limit requirement in GB/T 26572.

X: 表示该有害物质在该部件的至少一种均质材料中的含量超出 GB/T26572 标准规定的限量要求。

X: Indicates that the hazardous substance contained in at least one of the homogeneous materials used for this part is above the limit requirement of GB/T26572.

Contents

1. Safety and compliance.	7
1.1 Definition of Warnings and Cautions.	7
1.2 Safety symbols.	7
2. Introduction.	9
2.1 Scope of this manual.	9
2.2 ATEX directive implication.	9
2.3 Description.	10
2.4 Pump controller.	10
2.5 Logic interface.	11
2.6 Gas ballast control.	11
3. Technical data.	15
3.1 Operating and storage conditions.	15
3.2 Performance.	15
3.2.1 Pumping media.	16
3.2.2 Performance characteristics.	16
3.3 Mechanical data.	19
3.3.1 Sound and vibration data.	19
3.3.2 Construction.	20
3.4 Electrical data.	20
3.4.1 Electrical cables.	20
3.5 Logic interface data.	21
3.6 LED indicators.	23
4. Installation.	25
4.1 Safety.	25
4.2 System design considerations.	25
4.3 Unpack and inspect.	27
4.4 Position the pump.	27
4.4.1 Mechanical fixing.	27
4.5 Connect to the vacuum system.	28
4.6 Electrical installation.	29
4.6.1 Fuses and circuit breakers.	29
4.6.2 Electrical supply connection.	29
4.6.3 Disconnect the pump from the electrical supply.	29
4.7 Connection for remote control and monitoring.	29
4.7.1 Connect the logic interface to the control equipment.	29
5. Operation.	31

5.1	Operational modes.	31
5.2	Manual operation.	31
5.2.1	Start and stop.	32
5.2.2	Standby.	32
5.3	Parallel control and monitoring.	33
5.4	Analogue speed control.	33
5.4.1	Hardware configuration.	35
5.4.2	Operation.	35
5.5	Auto-run.	35
5.6	Use of gas ballast control.	35
5.6.1	Gas ballast control.	35
5.7	Start up procedure.	36
5.8	To achieve ultimate vacuum.	36
5.9	To pump condensable vapours.	36
5.10	Shut down.	36
6.	Maintenance.	38
6.1	Safety information.	38
6.2	Maintenance plan.	39
6.3	Inspect and clean the inlet strainer.	39
6.4	Clean the external fan cover.	39
6.5	Check the pump performance (service indicator).	40
6.6	Replace the tip-seals.	40
6.7	Replace the pump bearings (service indicator).	40
6.8	Replace the pump controller (service indicator).	41
6.9	Electrical safety check.	41
6.10	Service indicator codes.	41
7.	Fault finding.	43
7.1	The pump has failed to start or has stopped.	43
7.2	The pump has failed to achieve the required performance.	43
7.3	The pump has poor ultimate vacuum.	43
7.4	The pump is noisy.	44
7.5	The pump surface temperature is high.	45
7.6	Alarm indicator codes.	45
8.	Storage and disposal.	47
8.1	Storage.	47
8.2	Disposal.	47
9.	Spares and accessories.	48
9.1	Introduction.	48
9.2	Accessories.	49
9.2.1	Silencer.	50

9.2.2 Gas ballast adaptor.	50
9.2.3 Gas ballast adaptor blank.	50
9.2.4 Vibration isolators.	50
9.2.5 Inlet/exhaust filter.	50
9.2.6 Exhaust nozzle.	51
9.2.7 Chemical resistance conversion kit.	51
9.2.8 Electrical cables.	51
9.2.9 Pump-to-controller cable.	52
9.3 Spares.	52
9.3.1 Tip-seal kit	52
9.3.2 Cooling fan.	52
9.3.3 Gas ballast knob.	52
9.3.4 Silencer spares kit.	52
9.3.5 Inlet/exhaust filter spares.	53
9.3.6 Bearing replacement kit (not field serviceable).	53
9.3.7 Exhaust and ballast valve kit.	53
10. Service.	54
10.1 Return the equipment or components for service	54

List of Figures

Figure 1: nXDS scroll pump.	11
Figure 2: Quick start guide (manual control mode).	12
Figure 3: nXDS6i Performance characteristics.	17
Figure 4: nXDS10i Performance characteristics.	18
Figure 5: nXDS15i Performance characteristics.	18
Figure 6: nXDS20i Performance characteristics.	19
Figure 7: LED indicators.	23
Figure 8: Installation drawing.	26
Figure 9: User interface panel.	32
Figure 10: Logic interface connections - parallel control.	33
Figure 11: Logic interface connections - analogue speed control.	34
Figure 12: Analogue speed control.	34
Figure 13: Poor ultimate vacuum flow chart.	44
Figure 14: Noisy pump flow chart.	45
Figure 15: nXDS accessories.	49

1. Safety and compliance

1.1 Definition of Warnings and Cautions

NOTICE:



This manual meets our obligation to provide you with information. For safe operation from the start, read these instructions carefully before you install or commission the equipment.

Read all the safety instructions in this section and the rest of this manual carefully and make sure that you obey these instructions. The equipment must only be operated and maintained by trained personnel in the proper condition and as described in this instruction manual.

Obey local and state requirements and regulations. If you have any questions about safety, operation or maintenance of the device, please contact our nearest subsidiary.

Important safety information is highlighted as warning and caution instructions. Obey these instructions.



WARNING:

If you do not obey a warning, there is a risk of injury or death. Different symbols are used according to the type of hazard.



CAUTION:

If you do not obey a caution, there is a risk of minor injury, damage to equipment, related equipment or process.



NOTICE:

Information about properties or instructions for an action which, if ignored, will cause damage to the pump or the system.





We reserve the right to change the design and the stated data. The illustrations are not binding.

Keep the instructions for future use.

1.2 Safety symbols

The safety symbols on the products shows the areas where care and attention is necessary.

The safety symbols that follow are used on the product or in the product documentation.

	<p>Warning/Caution A safety instruction which must be followed.</p>
	<p>Warning - Heavy object Identifies a possible hazard from a heavy object.</p>
	<p>Warning - Dangerous voltage Identifies possible hazards from dangerous voltages.</p>
	<p>Warning - Hot surfaces Identifies a potential hazard from a hot surface.</p>
	<p>Warning - Risk of explosion An indication that there is a risk of explosion when you do the task.</p>

2. Introduction

2.1 Scope of this manual

This manual provides installation, operation and maintenance instructions for the nXDS series of scroll pump. The pump must be used as specified in this manual or the protection provided by the equipment may be impaired. Read this manual before installing and operating the pump.

2.2 ATEX directive implication



This equipment is designed to meet the requirements of Group II Category 3G in respects to ignition sources internal to the pump. This classification is in accordance with Directive 2014/34/EU.

The pumping mechanism and its mechanical components exposed to the "INTERNAL ATMOSPHERES" within the nXDS pump system is defined as: equipment group II, equipment category 3 - in accordance with the ATEX directive. This designation ONLY applies to the mechanical pumping mechanism, which is hermetically sealed from the external pump system and its operating environment. An ATEX category has not been assigned in respect of potential ignition sources on the outside of the equipment as the equipment has not been designed for use where there is an external potentially explosive atmosphere.

There is no potential source of ignition within the pump during normal operation but there may be potential sources of ignition under conditions of rare or unexpected malfunction as defined in the directive. As a result of this, it is necessary to consider the potential consequences of ignition sources occurring under rare or expected malfunction. (Ref ATEX137 1992/92/EC).

When flammable materials are present within the equipment you must:

- Not allow air to enter the equipment.
- Ensure the system is leak tight.
- Use an inert gas purge (for example, nitrogen) to dilute any flammable gasses or vapours entering the pump inlet, and use an inert gas purge to reduce the concentration of flammable gases or vapours in the pump and in the exhaust pipeline, to less than one quarter of the gases published Lower Explosion Limits (LEL).

Do not pump pyrophoric materials, process debris could produce an ignition source on the scroll surface.

Do not locate the pump in an ATEX zoned area, the ATEX specification is not applicable for external atmospheres.

When planning to pump hazardous substances with this pump, read the related chapters in the Safety Booklet and in these Operating Instructions first.

Further details can be obtained by contacting us.

2.3 Description

The nXDS pump is shown in [Figure: nXDS scroll pump on page 11](#).

The nXDS pump is a dry vacuum pump as all the bearings, with their hydrocarbon lubricant, are isolated from the vacuum space. The pump is suitable for use on vapour handling processes and may be used for some pumping applications involving corrosive substances. For information on pumping flammable gases, contact us.

The body of the pump includes a fixed scroll and an orbiting scroll. The orbiting scroll is controlled by an electric motor through an eccentric cam on the motor drive shaft. The movement of the orbiting scroll, meshed with the fixed scroll, forms successive crescent shaped volumes in the pump. Gas that enters the pump through the inlet is compressed by the movement of the orbiting scroll and swept towards the centre of the fixed scroll. The compressed gas enters the exhaust port near the centre of the fixed scroll and is exhausted from the pump through the outlet.

Refer to [Operating and storage conditions on page 15](#) for details of operating conditions.

2.4 Pump controller

The integral pump controller manages the supply of current to a three-phase electric motor in accordance with operating conditions. The controller monitors power and temperature and will protect the pump in the event of operation under sustained high load or under fault conditions.

The controller provides the user interface (refer to [Figure: nXDS scroll pump on page 11](#)). The pump may be operated in these modes:

- Manually, using the buttons on the interface panel. Refer to [Figure: Quick start guide \(manual control mode\) on page 12](#) and [Figure: User interface panel on page 32](#)
- Remotely via serial communications or digital and analogue process control (parallel), via the 15-way D-type logic interface connector. Refer to [Logic interface on page 11](#).

Figure 1 nXDS scroll pump

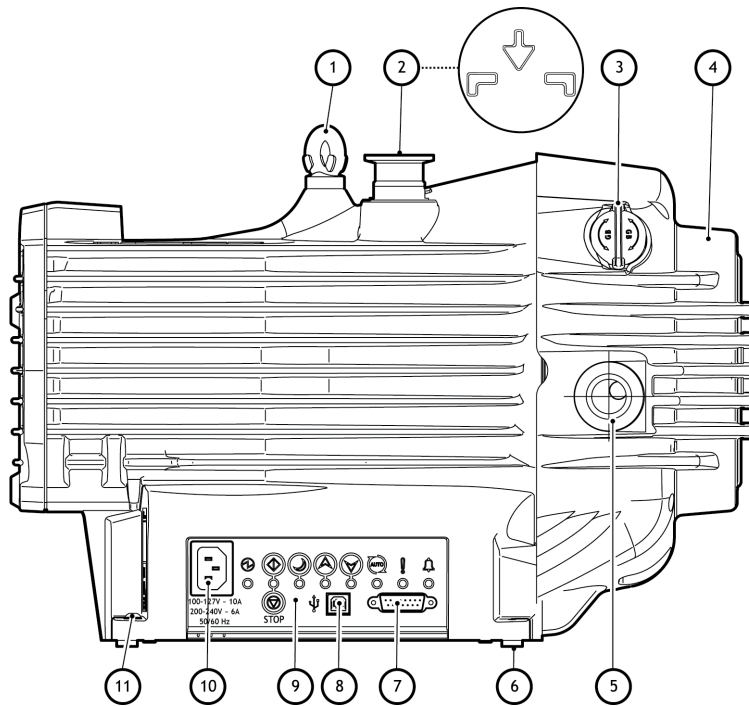

gea/0064/03/12

- | | |
|--------------------------------|---------------------------------|
| 1. Lifting eye | 2. NW25 inlet port |
| 3. Gas ballast control | 4. Cooling fan |
| 5. NW25 exhaust port | 6. Rubber feet |
| 7. 15-way D-type connector | 8. USB port (service mode only) |
| 9. User interface panel | 10. Mains power connector |
| 11. Secondary earth bond point | |

2.5 Logic interface

The pump controller can be operated via the 15-way D-type logic interface connector. The signals on the logic interface are of the following types:

- Control inputs: these are switch-type and analogue signals that controls the pump.
- Status outputs: these outputs identify the status of the system tab.

The logic interface is designed to support both serial control, parallel control and monitoring, operating through one connector. For serial control either RS232 or RS485 can be selected.

For Control Modes refer to [Table : nXDS Control modes on page 13](#).

For Logic interface data refer to [Logic interface data on page 21](#).

2.6 Gas ballast control

To pump high vapour loads, gas ballast can be delivered into the pump to prevent condensation of the vapour carried by the pumped gases.

Air can be introduced to the low vacuum stages through the gas ballast control ([Figure: nXDS scroll pump on page 11](#), item 3). Alternatively, an inert gas such as nitrogen can be

supplied through a suitable external valve and by using the appropriate adaptor, available as an accessory. Refer to [Spares and accessories on page 48](#).

Figure 2 Quick start guide (manual control mode)

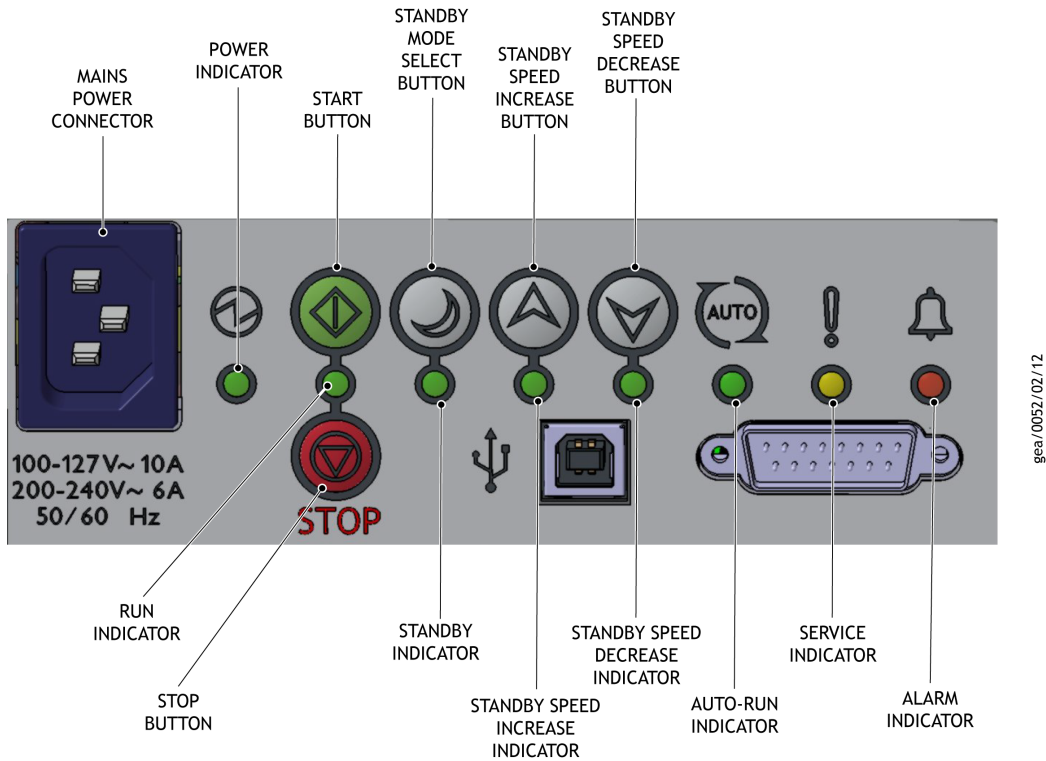

OPERATION	SELECT	STATUS	SECTION
Apply power	MAINS POWER	The pump will remain off (factory default). The POWER INDICATOR will illuminate.	Electrical supply connection on page 29
Start the pump	START BUTTON	The pump will accelerate up to full running speed.* The RUN INDICATOR will flash while accelerating. The RUN INDICATOR will remain on when the pump reaches full speed.	Start and stop on page 32
Stop the pump	STOP BUTTON	The pump will decelerate and stop running. The RUN INDICATOR will flash while decelerating. The RUN INDICATOR will go off when the pump has stopped.	Start and stop on page 32
Select and deselect the standby speed	STANDBY MODE SELECT BUTTON	When engaged, the STANDBY INDICATOR will illuminate and the pump will run at the standby speed setting. Factory default is 70% of full speed.	Standby on page 32

OPERATION	SELECT	STATUS	SECTION
Increase or decrease the pump speed when in standby mode	STANDBY SPEED INCREASE BUTTON	The pump speed will increase. The INCREASE STANDBY INDICATOR will remain illuminated when the pump reaches a maximum of 100% of full speed.	Standby on page 32
	STANDBY SPEED DECREASE BUTTON	The pump speed will decrease. The DECREASE STANDBY INDICATOR will remain illuminated when the pump reaches a minimum of 67% of full speed.	Standby on page 32
Select and deselect the Auto-run function	START or STOP BUTTON (>8 sec)	When engaged, the AUTO-RUN INDICATOR will illuminate. The pump will re-start automatically after the power has been restored.	Auto-run on page 35

* The pump is set to 30 Hz rotational full speed (factory default).

Table 1 nXDS Control modes

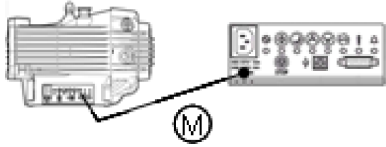
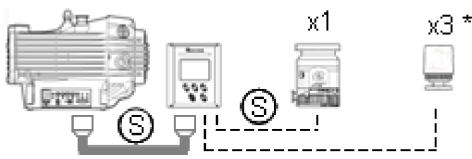
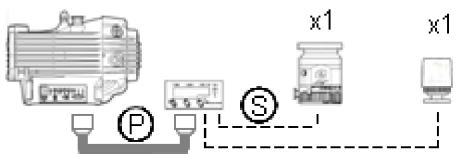
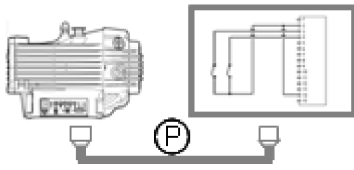
Configuration	Control mode	Manual/ Section
	Manual control via nXDS user interface	Introduction on page 9 Figure: Quick start guide (manual control mode) on page 12 in this manual
	Serial control via (TIC) *Turbo Instrument Controller or Turbo Controller	Manual D39722880
	Parallel control via (TAG) Turbo & Active Gauge Controller	Manual D39592880
	Parallel control via Digital I/O e.g. PLC control	Pump controller on page 10 in this manual

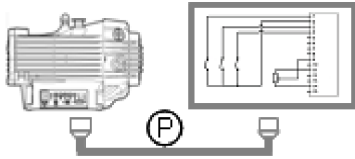
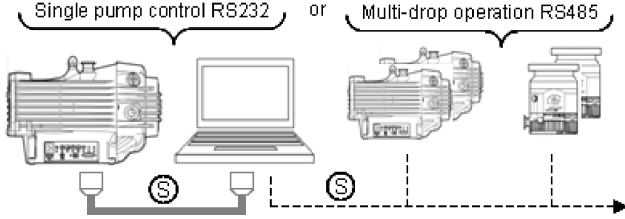
Configuration	Control mode	Manual/Section
	Parallel control via Digital I/O and Analogue speed control source	Analogue speed control on page 33 Figure: Logic interface connections - analogue speed control on page 34
 <p>Single pump control RS232 or Multi-drop operation RS485</p>	Serial control via RS232 or RS485 Comms Interface	Manual A73501860

- (M) Manual control
- (P) Parallel control
- (S) Serial control

Note:

Table : nXDS Control modes on page 13 shows our additional products, such as DX/nEXT Turbo pumps and active gauges that can be controlled at the same time using the various control methods displayed above.

3. Technical data



WARNING:

If the nXDS pump is operated outside the specified limits, the pump housing may become hot.

3.1 Operating and storage conditions

Table 2 Operating and storage conditions

Operating and storage conditions	nXDS
Ambient temperature range (storage)	- 30 °C to + 70 °C
Ambient temperature range (operation)	+ 5 °C to + 40 °C
Maximum humidity (storage in original packaging)	≤ 95% RH
Maximum humidity (operation)	90% RH

Table 3 Environmental conditions

Environmental conditions	
Pollution	Pollution degree 2
Installation	Installation category II
Altitude restriction	Max 2000 m*
Area of use	Indoor

* The product can be used up to an altitude of 3000 m. However, the product is only ETL certified for use up to 2000 m.

3.2 Performance

Table 4 General characteristics

Description	nXDS6i	nXDS10i	nXDS15i	nXDS20i
Peak pumping speed (m ³ h ⁻¹)	6.2	11.4	15.1	22.0
Maximum permitted continuous inlet pressure (mbar)*	200	200	200	50
Maximum permitted exhaust pressure (bar gauge)†	1	1	1	1
Maximum permitted gas ballast inlet pressure (bar gauge)	0.5	0.5	0.5	0.5
Maximum recommended chamber volume to pump down from atmospheric pressure (litres)‡	25	50	75	75
Maximum pressure rise when stopped, with no inlet or gas ballast flow (mbar)	7	7	7	7

Description	nXDS6i	nXDS10i	nXDS15i	nXDS20i
Leak tightness (mbar l s ⁻¹)	1 x 10 ⁻⁶	1 x 10 ⁻⁶	1 x 10 ⁻⁶	1 x 10 ⁻⁶

* These pumps are designed to pump down from atmospheric pressure, but prolonged operation at inlet pressures higher than specified may reduce bearing life.

† These pumps are intended to exhaust to atmospheric pressure. High exhaust pressure may reduce tip-seal life.

‡ Larger volumes may be pumped, but prolonged operation at inlet pressures higher than specified may reduce bearing life. The nXDS20i is optimised for constant throughput and is not recommended for cyclic duty.

 **Note:**

If the pump is operated outside the specified limits, then the pump housing may become hot; the controller may reduce the motor speed; and tip seal wear rate will be increased.

3.2.1 Pumping media



WARNING:

Do not use the nXDS pump to pump pyrophoric materials or dust.

The pump is designed to pump the following gases:

- Air
- Carbon dioxide
- Helium
- Carbon monoxide
- Nitrogen
- Argon
- Oxygen (O₂)

The pump can be used to pump water vapour. Caution must be taken to ensure that vapour does not condense inside the pump. Refer to [Gas ballast control on page 35](#) on how to prevent condensation of water vapour in the pump.

If pumping a vapour or gas not in the list above, contact us for advice.

3.2.2 Performance characteristics

The position of the gas ballast control defines the performance characteristics of the pump. These performance characteristics are listed in [Table: Performance characteristics on page 17](#).

Table 5 Performance characteristics

Description		nXDS6i	nXDS10i	nXDS15i	nXDS20i
Pump ultimate(mbar)	Gas ballast position 0	2×10^{-2}	7×10^{-3}	7×10^{-3}	3×10^{-2}
	Gas ballast position 1	5×10^{-2}	4×10^{-2}	4×10^{-2}	6×10^{-2}
Gas ballast flow ($l \text{ min}^{-1}$)	Gas ballast position 1	12	16	31	24

Figure 3 nXDS6i Performance characteristics

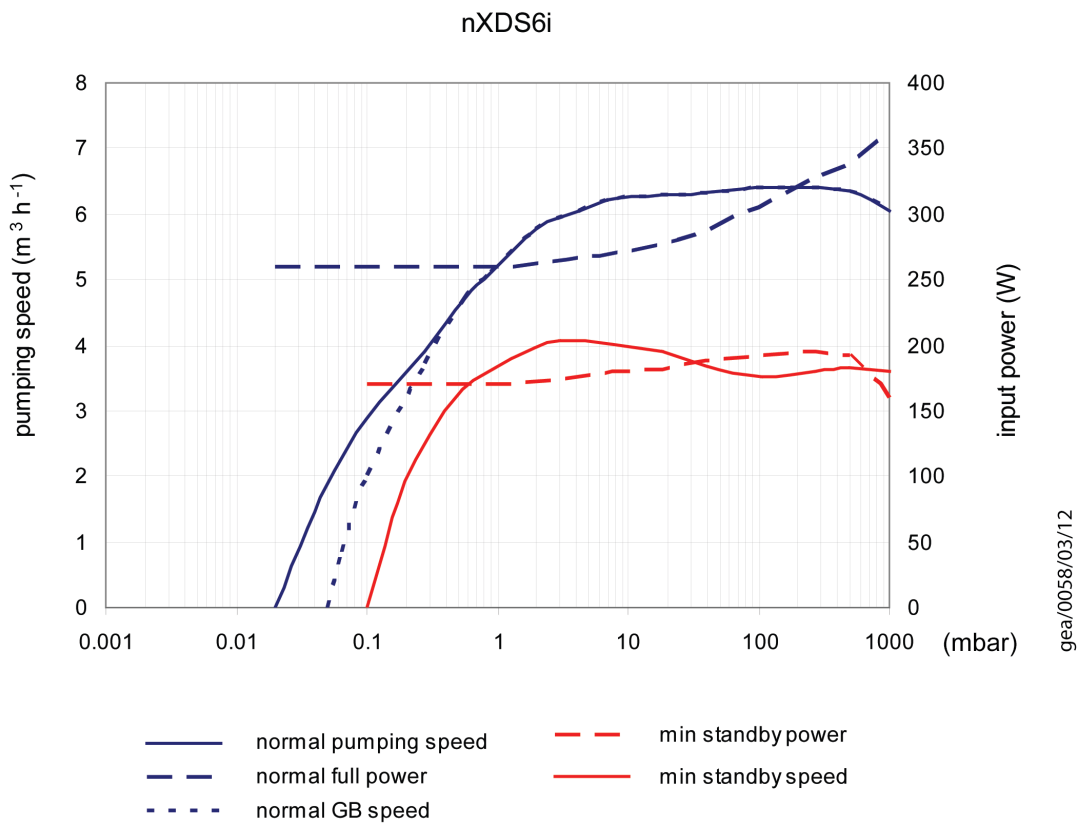
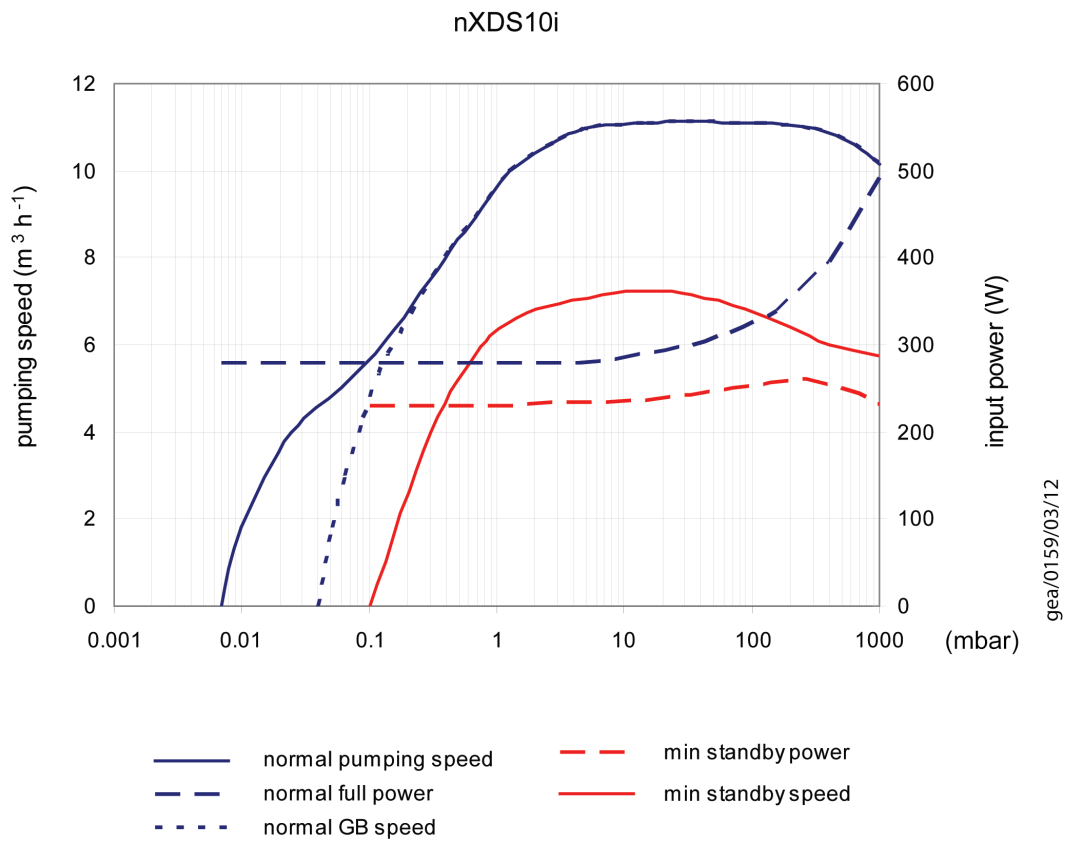
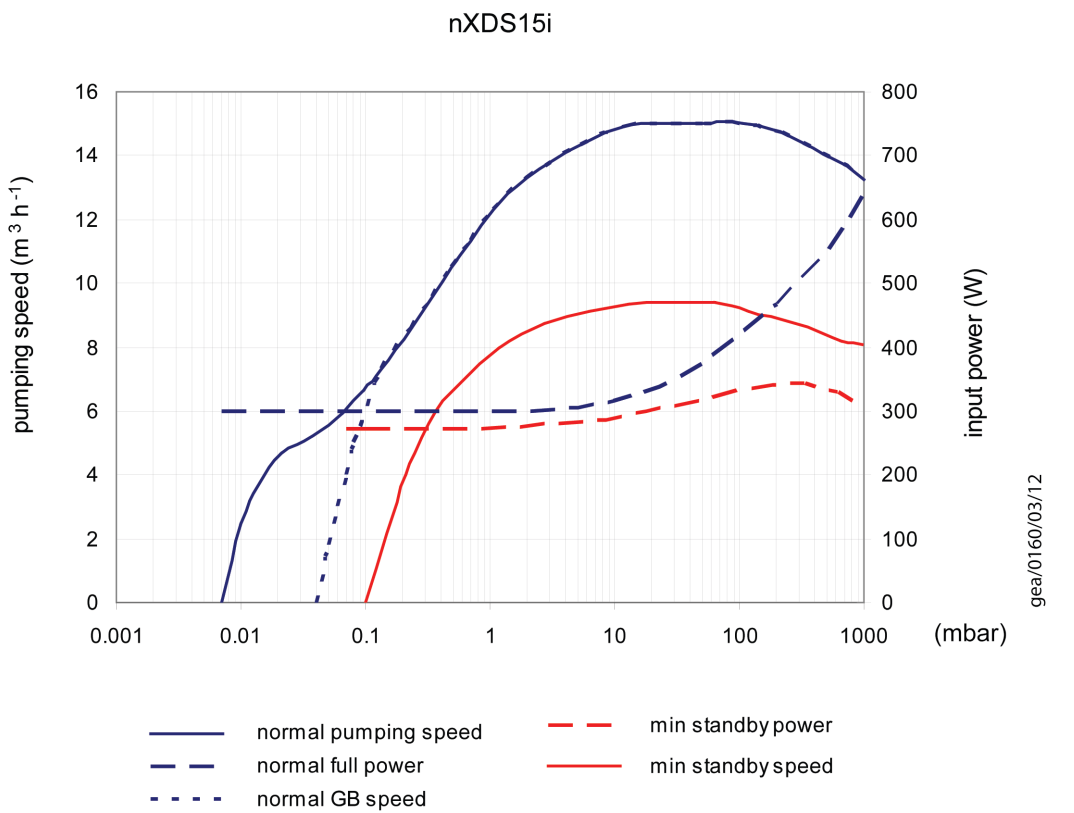

Figure 4 nXDS10i Performance characteristics



gea/0159/03/12

Figure 5 nXDS15i Performance characteristics



gea/0160/03/12

Figure 6 nXDS20i Performance characteristics

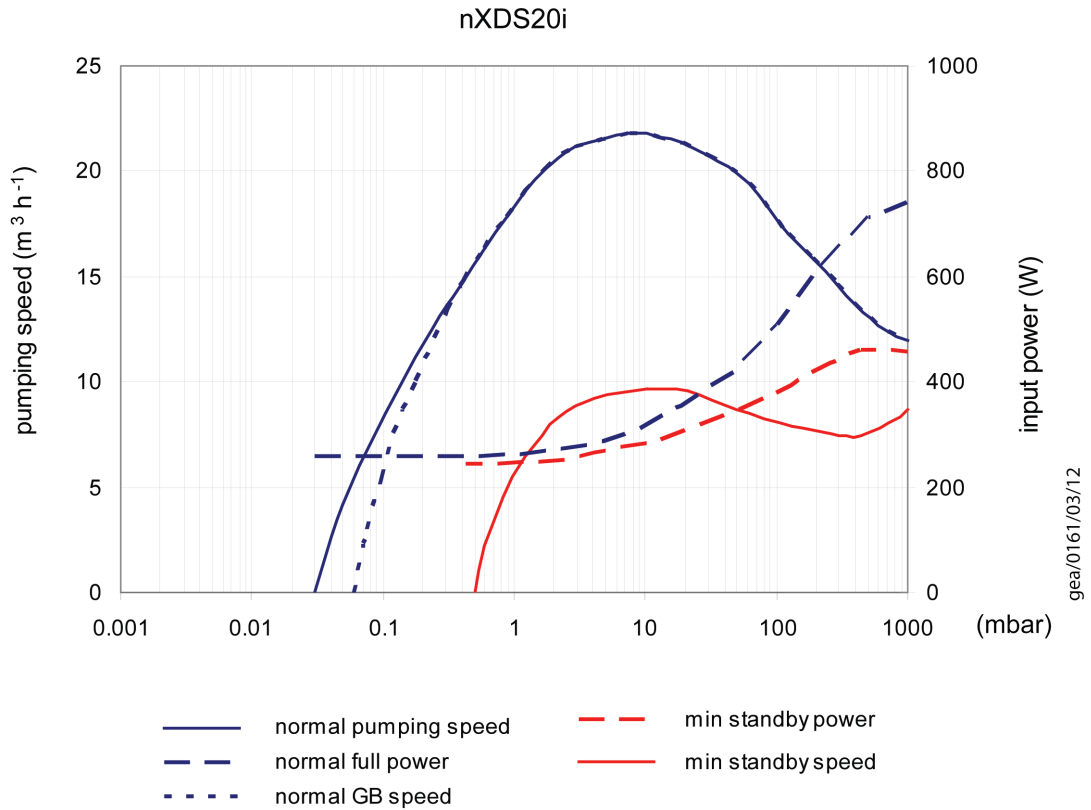

3.3 Mechanical data

Table 6 General mechanical data

Parameter	nXDS
Overall dimensions (L x W x H)	432 x 282 x 302 mm
Maximum tilt angle	10 degrees
Nominal rotational speed	1800 rpm (30 Hz)
Mass (maximum)	6i - 26.2 kg 10i - 25.8 kg 15i - 25.2 kg 20i - 25.6 kg
Inlet connection	NW25
Outlet connection	NW25

3.3.1 Sound and vibration data

Table 7 Sound and vibration data

Parameter	nXDS
Sound pressure, measured at ultimate vacuum 1 metre from the end of the pump to ISO 3744	52.0 dB (A) ± 2.5 Declared dual number noise emission values according with ISO 4871

Parameter	nXDS
Vibration: measured at the inlet port (ISO 3744)	Class 1C...< 4.5 mm s ⁻¹ (rms radial)

3.3.2 Construction

All surfaces of the pump which are exposed to the pumped gases are free from copper, zinc and cadmium. Exposed components include: anodised aluminium scrolls, aluminium housing, nickel-plated inlet and exhaust ports, PTFE composite tip-seals, various stainless steel parts and fluorocarbon elastomer seals.

Other materials of construction include steel, copper, hydrocarbon lubricant and chemically resistant polymers.

3.4 Electrical data

Table 8 Electrical ratings for continuous operation

Pump	Supply (Vac rms)	Phase	Frequency (Hz)	Input current (A rms)
All variants	100 - 127 ± 10%	Single	50 - 60	10
	200 - 240 ± 10%	Single	50 - 60	6

Table 9 Recommended regional supply protection

Area	Voltage	Rating
UK	230 V	10 A, 250 V a.c. rms
Europe	230 V	10 A, 250 V a.c. rms
US	120 V	10 A, 250 V a.c. rms
Japan	100 V	10 A, 250 V a.c. rms

3.4.1 Electrical cables

Recommended cord sets and fuses for regional requirements.

Table 10 Recommended cord sets

Description	Rating	Coupler type	Item number
Cord set assembly, UK	Cable Style = H05VV-F, 3 x 1.0 mm ² , 300 V, 70 °C, maximum length of 2.0 metres Plug Type = BS1363 UK plug Appliance Coupler = IEC60320 style C14 Fuse Type = BS1363 10 Amp fuse, to an IEC60320 style	Straight entry	A50505000
Cord set assembly, Europe	Cable Style = H05VV-F, 3 x 1.0 mm ² , 300 V, 70 °C, maximum length of 2.0 metres	Straight entry	A50506000

Description	Rating	Coupler type	Item number
	Plug Type = European Schuko VDE approved, 16 A 250 V rated with dual earthing contact Appliance Coupler = IEC60320 style C14		N/A
Cord set assembly, USA/Canada	Cable style = SJT, 3 x 18 AWG, 300 V, 70 °C, VW-1 maximum length of 2.0 metres Plug Type = NEMA, 5-15P plug Appliance Coupler = IEC 60320 style C14	Straight entry	A50507000

3.5 Logic interface data

The pumps have a 15-way D-type logic interface connector located on the user interface panel ([Figure: nXDS scroll pump on page 11](#), item 7). The logic interface connector can be plugged directly into the 200 W Turbo Instrument Controller (TIC) or Turbo Controller, or Turbo and Active Gauge controller (TAG). A suitable connector mating half must be used (not supplied) to connect the nXDS pump to the customer control system. Refer to [Table: Logic interface technical data on page 21](#) for the interface technical data and [Table: Logic interface connector pins on page 22](#) for the logic interface pins for the electrical connections.

Table 11 Logic interface technical data

Logic interface description	
Connector*	15-way D-type (male)
Start, serial enable and remote enable:	
Enable control voltage: low (closed)	0 to 0.8 V d.c. ($I_{OUT} = 0.55$ mA nominal)
Disable control voltage: high (open)	4 to 26.4 V d.c. (Internal pull up to 6.4 V nominal)
Standby control input:	
Enable control voltage: low (closed)	0 to 0.8 V d.c. ($I_{OUT} = 0.3$ mA nominal)
Disable control voltage: high (open)	4 to 26.4 V d.c. (Internal pull up to 3.2 V nominal)
Analogue and RS485 enable control inputs:	
Enable control voltage: low (closed)	0 to 0.8 V d.c. ($I_{OUT} = 0.55$ mA nominal)
Disable control voltage: high (open)	4 to 52.8 V d.c. (Internal pull up to 6.4 V nominal)
Analogue speed input	0 to 10 V d.c. directly proportional to the motor speed e.g. 0 V = 0 Hz, 10 V = 30 Hz
Voltage accuracy	± 5% full scale
NORMAL status output:	

Logic interface description	
Type	Open collector transistor plus pull up resistor.
< Normal speed (default 80%)	OFF (4.7 k pull up + diode to 12 V d.c.)
≥ Normal speed	ON (< 0.8 V d.c. sinking 10 mA)
Maximum current rating	10 mA
Maximum voltage rating	28.8 V d.c.
FAIL status output:	
Type	Open collector transistor plus pull up resistor.
Fail	OFF (4.7 k pull up + diode to 12 V d.c.)
OK	ON (< 0.8 V d.c. sinking 10 mA)
Maximum current rating	10 mA
Maximum voltage rating	28.8 V d.c.
Analogue 10 V reference	+ 10 V d.c. analogue voltage reference Unipolar output with diode protection
Voltage accuracy	± 2% full scale
Output current	≤ 5 mA for specified accuracy

* Mating half of connector not supplied.

Table 12 Logic interface connector pins

Pin Number	Signal	Polarity	Use
1	Analogue Speed Enable-control Input	-	Connect to Pin 2 (0 V) to enable analogue speed control via Pin 9.
2	0 V Control Reference	-	0 V reference for ALL control and status signals listed within this table.
3	START / STOP - Control Input	-	Connect to Pin 2 (0 V) to START the nXDS pump system.
4	STANDBY - Control Input / Serial-RX/RS485 A-	-	Connect to Pin 2 (0 V) to enable STANDBY speed when the SERIAL ENABLE control input is inactive.
5	Serial Enable - Control Input	-	Connect to Pin 2 (0 V) to enable serial communications.
6	RS232/RS485 - Control Input	-	Default configuration is RS232 with Pin 6 unconnected. Connect to Pin 2 (0 V) to enable RS485 serial communications.
7	FAIL - Status Output/ Serial-TX/RS485 B+	-	Logic HIGH when a fail or fault condition exists and the SERIAL ENABLE control input is inactive.
8	0 V Control Reference	-	0 V reference for all control and status signals listed within this table.

Pin Number	Signal	Polarity	Use
9	Analogue Speed - Control Input	-	0-10 V analogue Input: 0 V = 0% Speed; + 10 V = 100% speed
10	Chassis/Screen	-	Screen
11	+ 10 V Analogue Reference - Control Output	Positive	+ 10 V analogue voltage reference output: 5 mA, unipolar output, diode protected.
12	Chassis/Screen	-	Screen
13	Not Connected	-	Unused control pin.
14	REMOTE - Control Input	-	Connect to Pin 2 (0 V) to enable remote control via Parallel or Serial control modes.
15	NORMAL - Status output	-	Logic LOW when the pump rotational speed is at normal speed or above.

3.6 LED indicators

Figure 7 LED indicators

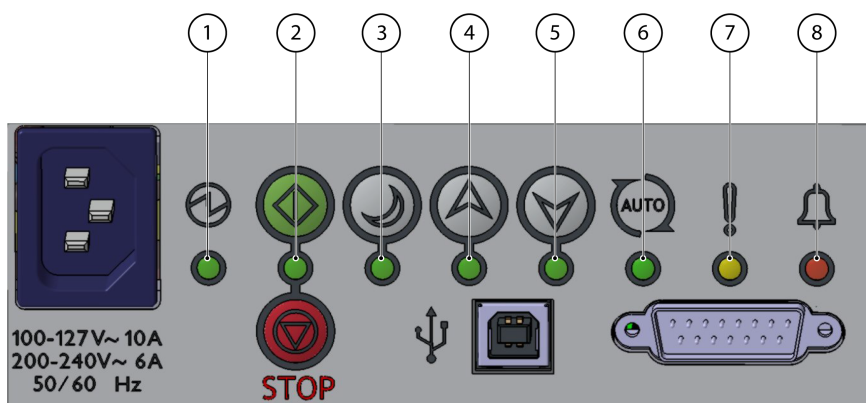

The nXDS pump has eight indicator LED's

Table 13 LED indicators

LED	Description	Details
1	Power indicator	Indicates that electrical mains supply to the pump is ON
2	Run indicator	Indicates that the pump is running. Refer to Start and stop on page 32 .
3	Standby mode indicator	Indicates that the Standby mode has been selected. Refer to Standby on page 32 .
4	Standby speed increase indicator	The indicator will blink with every short push of the Standby speed increase button. The indicator will remain ON when maximum standby speed has been reached. Refer to Standby on page 32 .

LED	Description	Details
5	Standby speed decrease indicator	The indicator will blink with every short push of the Standby speed decrease button. The indicator will remain ON when minimum standby speed has been reached. Refer to Standby on page 32 .
6	Auto-run indicator	Indicates that the Auto-run mode has been selected. Refer to Parallel control and monitoring on page 33 .
7	Service indicator	Indicates that a service interval has been reached. Refer to Service indicator codes on page 41 .
8	Alarm indicator	Indicates an Alarm has been triggered. Refer to Alarm indicator codes on page 45 .

4. Installation

4.1 Safety



WARNING:

Obey the safety instructions in this section and take note of appropriate precautions. If not, injury to people and damage to equipment can result.

Prevent any part of the human body coming into contact with the vacuum.

The nXDS pump is not intended for pumping explosive gases continuously (refer to [ATEX directive implication on page 9](#)).

Ensure that the pump is suitable for the application. If in doubt, refer our guidelines on vacuum pump and vacuum system safety, or contact us for advice.

A suitably trained and supervised technician must perform the installation of the pump. Obey the safety instructions listed below, especially when connecting the pump into an existing system. Details of the specific safety precautions are given at the appropriate point in the instructions.

- Wear the appropriate safety clothing if contact with contaminated components is anticipated. Dismantle and clean contaminated components inside a fume cupboard.
- Vent and purge the vacuum system before starting installation work.
- Ensure that the installation technician is familiar with the safety procedures that relate to the products handled by the pumping system.
- Disconnect the other components in the pumping system from the electrical supply to prevent accidental operation.

4.2 System design considerations

Consider the following points when designing the pumping system:

We recommend you to use a foreline vacuum isolation valve to allow the pump to warm up before pumping condensable vapours or if a vacuum needs to be maintained when the pump is not running.

Use a suitable valve to isolate the pump from the vacuum system if the pump needs to warm up before pumping condensable vapours or if vacuum needs to be maintained when the pump is switched off.

Avoid high levels of heat input into the pump from the process gases, otherwise the pump may overheat and cause the thermal protection system to operate.

Ensure that the exhaust pipeline cannot become blocked. If an exhaust isolation valve is installed, ensure that the pump cannot be operated with the valve closed. Refer to [Connect to the vacuum system on page 28](#).

Provide for a purge of inert gas when the pumping system is shut down, to dilute dangerous gases to safe concentrations. Contact our Application team for further advice on dilution requirements if required.

Figure 8 Installation drawing

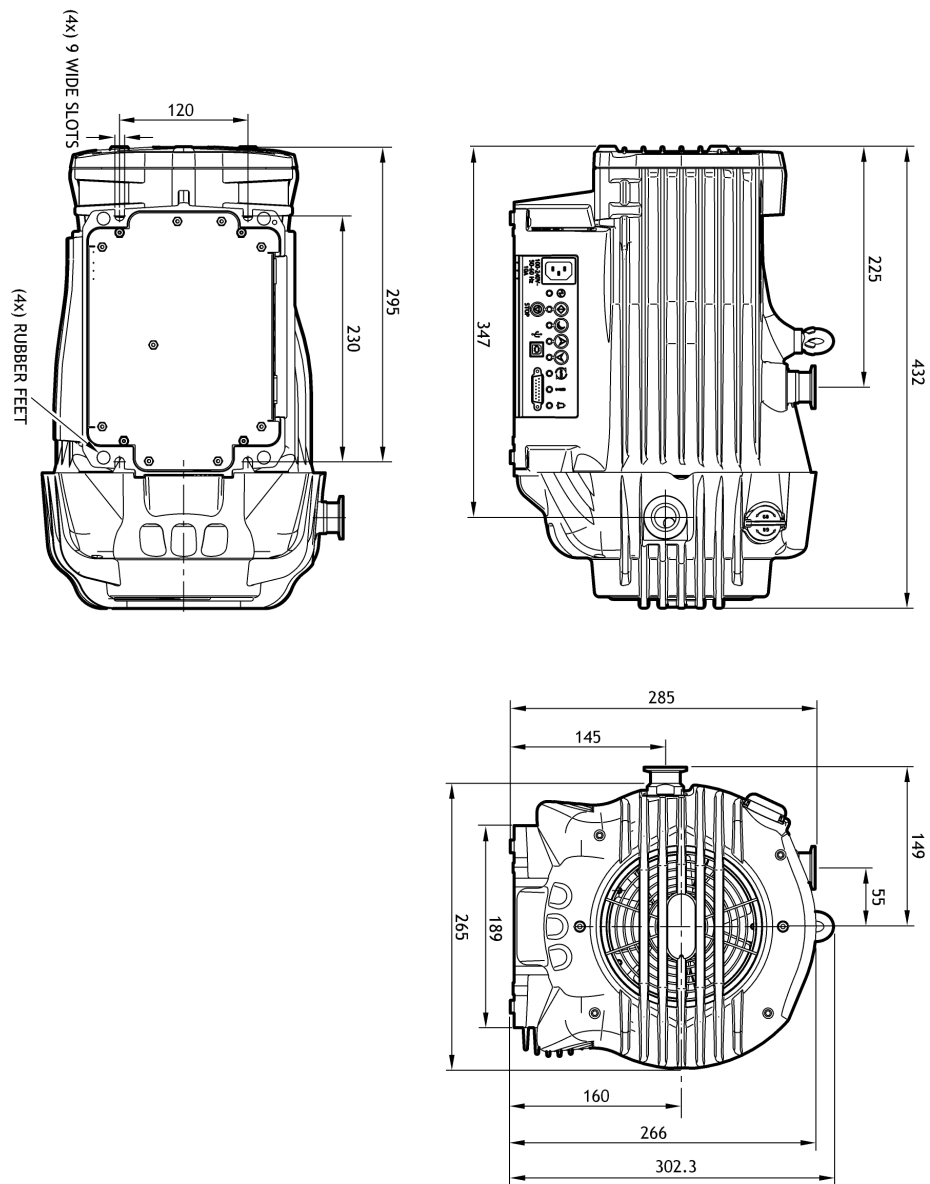

dcs/6000/001

Note:

All dimensions in mm. External dimensions are the same for all variants.

4.3 Unpack and inspect

WARNING:



Use suitable lifting equipment to move the nXDS pump. The maximum pump mass is 27 kg.

Mechanical lifting equipment should be attached to the lifting eye; Loose slings should not be used.

Take care when moving the pump into position. Its mass may make it difficult to slide. The fan cowl is shaped to provide a handhold for positioning; the pump must not be lifted using this handhold.

Remove all packing materials, remove the pump from its packing box, remove the protective covers from the inlet and outlet ports and inspect the pump. If the pump is damaged, notify the supplier and carrier in writing. State the item number of the pump together with the order number and supplier's invoice number. Retain all the packing materials for inspection. Do not use the pump if it is damaged. If the pump is not to be used immediately, replace the protective covers. Store the pump in the conditions described in [Storage on page 47](#). Refer to [Disposal on page 47](#) for disposal of materials.

4.4 Position the pump



WARNING:

If the pump is to be used on the floor of a work area, position the power lead and the exhaust and inlet hoses with care. Ensure that personnel in the area are aware of any obstructions around the pump.

Provide a firm, level platform for the pump. Locate the pump so that the gas ballast control and the user controls are accessible.

If the pump will be located inside an enclosure, ensure that there is adequate ventilation at both ends of the pump, so that the ambient temperature around the pump does not exceed 40 °C. There must be a minimum space of 25 mm between the pump and the enclosure walls.

4.4.1 Mechanical fixing

Note:

The pump can be secured by using the four holes located on each corner of the pump base. We recommend you to use M8 bolts.

4.5 Connect to the vacuum system



WARNING:

If pumping dangerous gases or vapours, connect the exhaust to a suitable treatment plant to prevent the discharge of dangerous gases and vapours to the surrounding atmosphere.

If the pump is operated with the exhaust line blocked, high pressure may be generated in the exhaust line pipework.

Refer to [Figure: nXDS scroll pump on page 11](#). Before connecting the pump to the vacuum system, remove the plastic cap from the inlet and exhaust, and ensure that the inlet strainer is fitted to the pump inlet port. Use appropriate NW25 vacuum fittings for connection to the system.

Take note of the following information when connecting the pump to the vacuum system:

- To minimise noise and exhaust emissions, it is recommended that the pump is connected to an exhaust line or a silencer (refer to [Spares and accessories on page 48](#)).
- For optimum pumping speeds, ensure that the pipeline connected to the pump inlet is as short as possible and has a suitable internal diameter.
- Support the vacuum pipeline to prevent loading of the coupling joints.
- A pressure of 3 bar(g) may be generated in the exhaust pipework if the pump is operated with the exhaust line blocked. Connect the pump using appropriate pipework and fittings.
- If necessary, incorporate flexible bellows in the system pipelines to reduce the transmission of vibration and to prevent loading of the coupling joints. If using flexible bellows, ensure that bellows have a maximum pressure rating which is greater than the highest pressure that can be generated in the system. Manufacturer's bellows are recommended.
- Incorporate an inlet isolation valve in the pipeline from the vacuum system to the pump to isolate the vacuum system from the pump when it is switched off and prevent suck-back of process gases and debris into the vacuum system.
- Ensure that the sealing surfaces are clean and scratch-free.

We recommend you to use an exhaust extraction system suitable for use with all process gases that will be pumped. Ensure that the exhaust extraction system cannot become blocked or obstructed when the pump is operating.

A small amount of tip seal wear product may collect in the exhaust duct of the pump. The dust may be blown out with the initial burst of air after the pump has been vented. This is quite common and the amount of dust seen will reduce over time.

Leak test the system and seal any leaks found after pump installation.

4.6 Electrical installation

4.6.1 Fuses and circuit breakers

WARNING:



Ensure that the electrical installation of the pump conforms to local and national safety requirements. The pump must be connected to a suitably fused and protected electrical supply with a suitable earth point. For recommended fuse ratings and cord sets refer to [Electrical data on page 20](#).

CAUTION:



Ensure that access to the pump electrical supply cable is not obstructed when locating the pump.

If using an earth leakage device, for example, a Residual Current Device (RCD), use a 30 mA (minimum) rated unit to avoid trip during start up.

The live conductor is fused inside the pump controller whilst the neutral conductor is not. An external RCD should be installed to guard against damage in the event of a short circuit between neutral and earth.

For recommended protection ratings, refer to [Table: Recommended regional supply protection on page 20](#) in [Electrical data on page 20](#).

4.6.2 Electrical supply connection

Use an IEC60320 connector (C13) and cable that meets local electrical standards when connecting to the pump. The pump must be earthed via the earth conductor of the IEC60320 connector. A list of cable specifications is available in [Electrical data on page 20](#) of this manual.

We recommend you to fit a separate earth to the pump using a non-insulated braid or a separate insulated green or yellow conductor. The conductor must be a minimum of 14 AWG. Use the M5 x 10 screw and shake proof washer located on the rear of the pump housing (refer to [Figure: nXDS scroll pump on page 11](#)) to secure the earth conductor to the pump.

4.6.3 Disconnect the pump from the electrical supply

Before removing the physical electrical supply connection to the pump, via the IEC60320 cable (C13), isolate the Mains supply (refer to [Figure: nXDS scroll pump on page 11](#)).

4.7 Connection for remote control and monitoring

To operate the pump using parallel or serial control, use the 15-way D-type connector on the user interface panel (refer to [Figure: nXDS scroll pump on page 11](#), item 7). Refer to [Table: Logic interface connector pins on page 22](#) for full details of the logic interface pins.

4.7.1 Connect the logic interface to the control equipment

The pump can be controlled using a hardware parallel control interface and via commands sent over a serial interface.

To control the pump using the hardware parallel interface, refer to [Parallel control and monitoring on page 33](#) for more information. To use the serial interface or to work with a mixture of parallel and serial control, refer to manual A73501860.

5. Operation

**WARNING:**

Ensure that the system design does not allow the exhaust pipeline to become blocked.

**CAUTION:**

A fine dust may be emitted from the exhaust of the scroll pump during start up, particularly when the pump is new or if new tip seals are fitted.

5.1 Operational modes

The nXDS pump implements three control modes:

- Manual Control Mode - using buttons on user interface panel.
- Parallel Control Mode - via 15-way D-type logic interface connector on user interface panel.
- Serial Control Mode (including Serial Interlock) - via 15-way D-type logic interface connector on user interface panel.

The Control Mode is determined by the way the pump is started. Once started, the pump can only be stopped by the mode in which it was started, unless the power is cycled by isolation from the electrical supply.

5.2 Manual operation

The pump control functions of the user interface panel are detailed in [Figure: User interface panel on page 32](#).

Figure 9 User interface panel

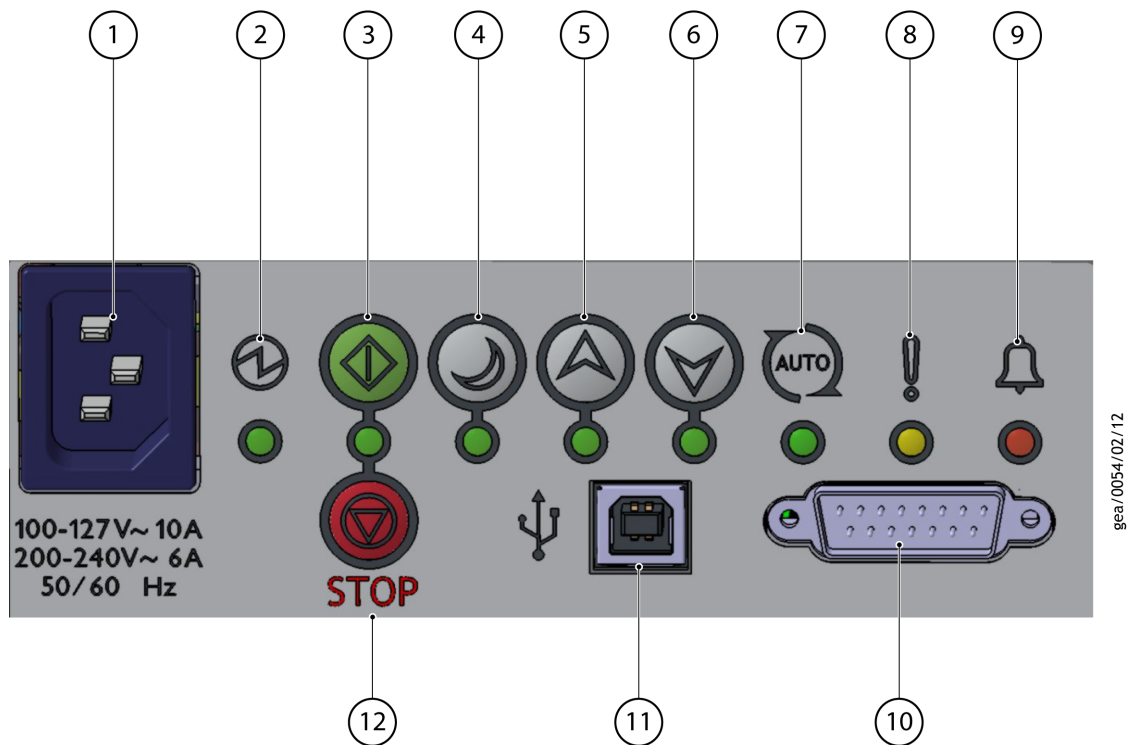

- | | |
|---|---|
| 1. Mains power connector | 2. Power connected indicator |
| 3. Start button with indicator | 4. Standby button with indicator |
| 5. Increase standby speed button with indicator | 6. Decrease standby speed button with indicator |
| 7. Auto-run enabled indicator | 8. Service indicator |
| 9. Alarm indicator | 10. 15-way D-type connector |
| 11. USB port (Service mode only) | 12. Stop button |

gea/0054/02/12

5.2.1 Start and stop

Use the buttons ([Figure: User interface panel on page 32](#), items 3 and 12) to start and stop the pump. Note that the stop command does not isolate the pump from the electrical supply.

5.2.2 Standby

Operation at reduced speed will further improve tip seal and bearing service life. Vacuum performance will be reduced when operating at standby speed.

Press the Standby button to select standby mode. The pump will initially run at factory default standby speed (70% of full speed). The speed can be adjusted using the increase and decrease standby speed buttons. The maximum standby speed is 100% of the default run speed and the minimum standby speed is 67% of the default run speed. A single short push will change the speed by 1% of the default run speed, holding the button will change the speed by 1%/sec. Once adjusted, the pump will return to this new user-defined speed each time standby speed is selected.

The Standby button must be pressed to return to normal run speed.

5.3 Parallel control and monitoring

Figure 10 Logic interface connections - parallel control

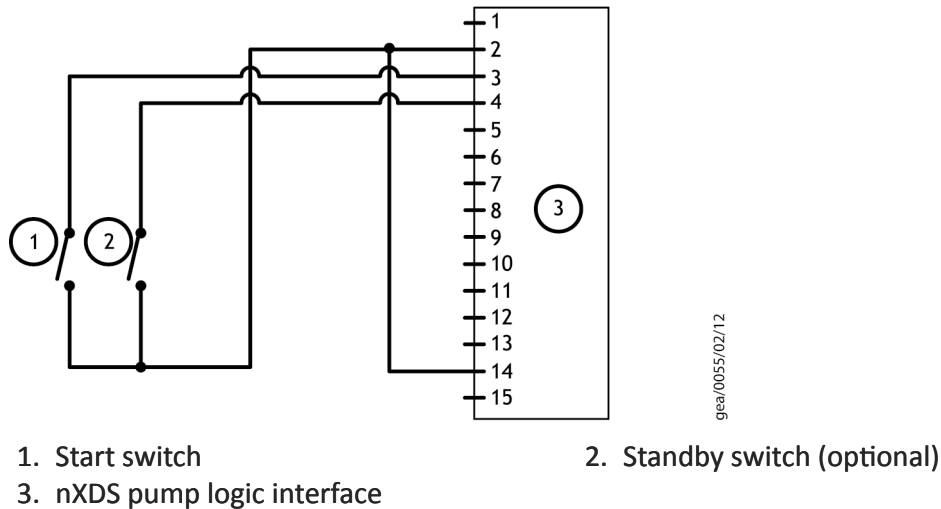

CAUTION:

If using the normal and fail lines to drive the coils of d.c. relays, include a back EMF suppression diode in parallel with each relay coil to protect the pump.

Connect the control equipment to the control input pins of the logic interface mating half. Refer to [Table: Logic interface technical data on page 21](#) to identify the logic interface connector pins. The control inputs are as follows:

- Start
- Standby speed
- Analogue speed

To activate any of these control inputs, connect the relevant control input (pin 14) to the 0 V control reference.

To monitor the normal status output, connect the control equipment to the Normal status output (pin 15) and to pin 2 of the logic interface mating half. The output can be used to control other devices in the pumping system. The output can drive a low power relay of up to 24 V coil rating (up to 10 mA).

To monitor the fail status output, connect the control equipment to the fail output (pin 7) and to pin 2 of the logic interface mating half. The output can be used to control other devices in the pumping system. The output can drive a low power relay of up to 24 V coil rating (up to 10 mA).

5.4 Analogue speed control

The Analogue Speed input is a process control source which enables the nXDS Scroll pump to run at variable operating speeds. This speed control source is an alternative to standby speed control.

Figure 11 Logic interface connections - analogue speed control

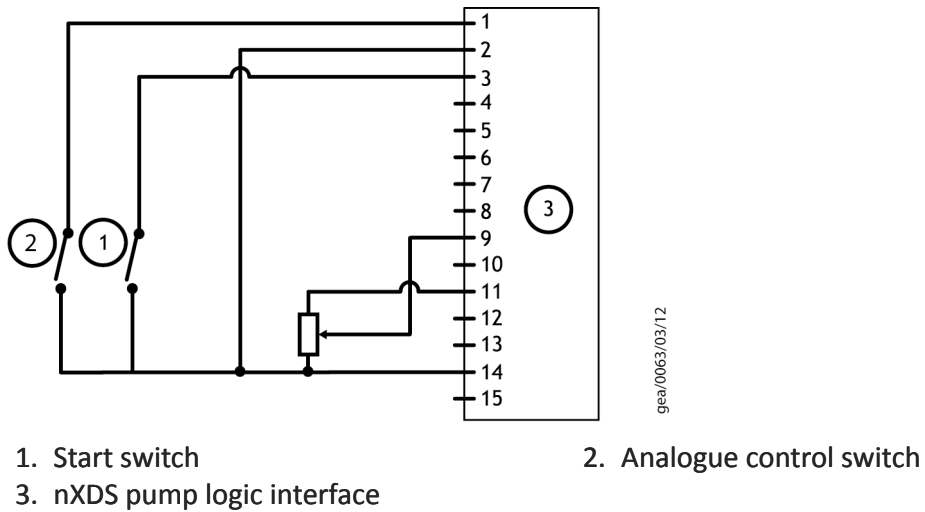

Note:

0.1 V \equiv 1% of Default Run Speed.

Figure 12 Analogue speed control

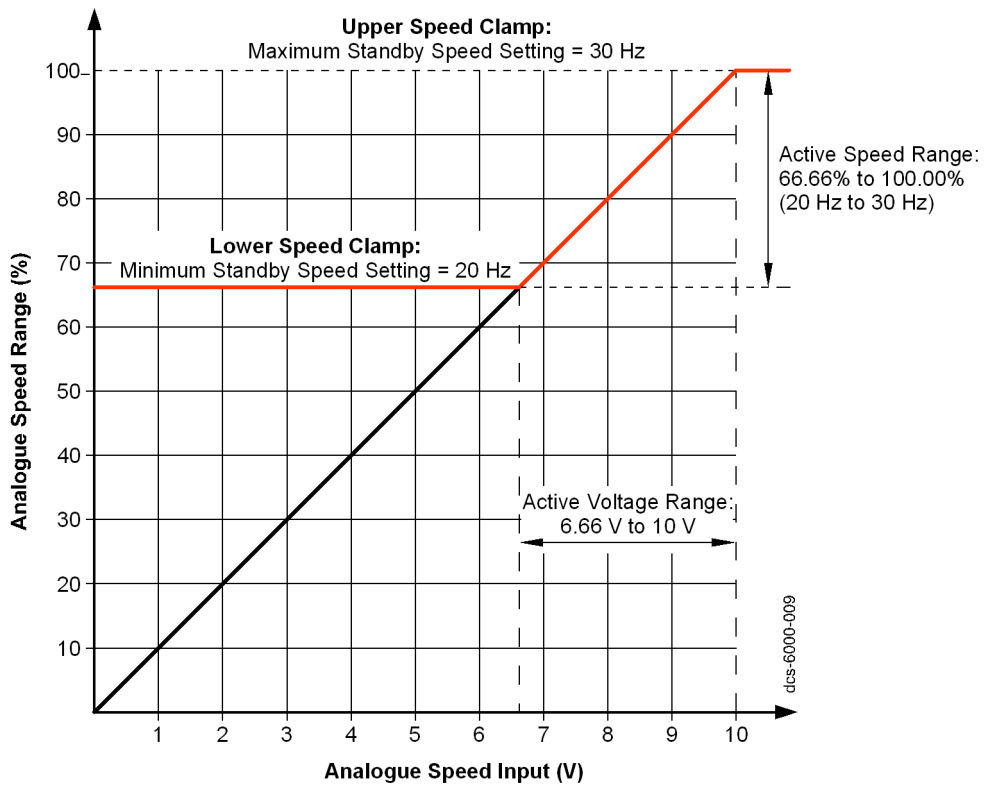

Note:

Voltages below 6.7 V will result in a clamped speed of 67% of full speed.

5.4.1 Hardware configuration

Using the 15-way D-type connector ([Figure: nXDS scroll pump on page 11](#), item 7) apply the following signal configurations to enable the Analogue Speed Control source (refer to [Table: Logic interface connector pins on page 22](#)):

Connect the Analogue Speed Enable control input (pin 1) to the 0 V Control Reference (pin 2).

Connect a suitably calibrated analogue voltage source (0 to + 10 V), for example, (DAC) to the analogue speed control input (pin 9). Alternatively connect the output of a potentiometer referenced to the pump reference voltage (pin 11) to the analogue speed control input (pin 9). Refer to [Figure: Logic interface connections - analogue speed control on page 34](#). The 0 V rail of the external voltage source must be connected to the 0 V Control Reference (pin 2) of the pump controller.

5.4.2 Operation

- A + 10 V input equates to a mechanical running speed which is equal to: 100% of the default run speed, that is, 30 Hz.
- The minimum running speed provided by the Analogue Speed control source, is clamped at the minimum Standby Speed Setting, that is, approximately 67% of the default run speed of 20 Hz.
- The maximum running speed provided by the Analogue Speed control source is clamped by the maximum Standby Speed Setting, that is, 100% of the default run speed of 30 Hz.

5.5 Auto-run

The auto-run setting configures the pump to start at power-up without any customer intervention. This parameter is customer configurable via serial communications or using the START / STOP buttons. Holding down either the START or STOP button, for more than eight seconds, will enable or disable the auto-run setting. The status of the auto-run setting is visible via the auto-run LED.

The pump can be stopped using either manual, parallel or serial control modes whilst in auto-run.

5.6 Use of gas ballast control

The gas ballast control can be used to optimise the performance of the scroll pump for the application. The performance characteristics of the pump with gas ballast on are shown in [Performance characteristics on page 16](#). The position of the gas ballast control can be changed when the pump is either off or operating.

5.6.1 Gas ballast control

Use the gas ballast control to introduce air into the final stage of the pump. Use of gas ballast will reduce the condensation of vapours in the pump. The condensates would contaminate the pump.

There are only two positions, 0 and 1. The gas ballast control knob will rotate 360° in either direction at 90° intervals.

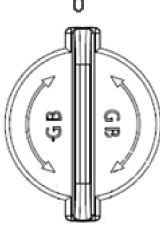
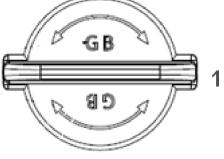
<p>Gas ballast OFF (position 0). Use this setting to:</p> <ul style="list-style-type: none"> • achieve ultimate vacuum • pump dry gases. 	
<p>Gas ballast ON (position 1). Use this setting to:</p> <ul style="list-style-type: none"> • pump low concentrations of condensable vapours • decontaminate the pump. 	

5.7 Start up procedure

Use the procedure below to start up the pump:

1. Ensure that any vacuum system isolation valve is closed (if fitted).
2. With the mains supply to the pump isolated, connect a recommended lead to the electrical socket on the pump (refer to [Figure: nXDS scroll pump on page 11](#)).
3. Apply power.
4. Start the pump system using the appropriate control source, that is, using the Start button in manual control mode (refer to [Figure: User interface panel on page 32](#)); the Start/Stop control input (refer to [Table: Logic interface connector pins on page 22](#), pin 3) in parallel control mode or a Start command in serial control mode.
5. Open the vacuum system isolation valve, if fitted.

5.8 To achieve ultimate vacuum

In order to achieve the best possible vacuum, the pump should be operated with the gas ballast control turned off. However, if the pump, or elements of the vacuum system it is attached to, are new or have been newly fitted, some atmospheric moisture may be present. If atmospheric moisture is present, run the pump with gas ballast on for 20 minutes before turning gas ballast off. If moisture can remain, the performance of the pump will be impaired.

5.9 To pump condensable vapours

Select gas ballast ON when there is a high proportion of condensable vapours in the process gases. This will assist the vapours to pass through the pump without condensing and keep the pump performance from degrading.

5.10 Shut down

Use the procedure below to shut down the pump:

1. If shutting the pump down prior to a period of storage, remove any process gases by running on a gas ballast for at least one hour.

2. Close any vacuum system isolation valves to prevent suck-back into the vacuum system (where fitted).
3. Stop the pump system using the appropriate control source, that is, using the Stop button in manual control mode (refer to [Figure: User interface panel on page 32](#)); the Start/Stop control input (refer to [Table: Logic interface connector pins on page 22](#), pin 3) in parallel control mode or a Stop command in serial control mode.
4. Vent the nXDS pump system using the gas ballast control or the valve on the inlet.
5. Isolate the Mains supply.

6. Maintenance

6.1 Safety information



WARNING:

Obey the safety instructions in this section and take note of appropriate precautions. Failure to observe these instructions may result in injury to people and damage to equipment.



WARNING:



In order to maintain the ATEX certification, all maintenance work must be carried out in accordance with this nXDS instruction manual, the Replacement tip seal manual and the nXDS maintenance manual, only using our genuine spare parts.



WARNING:

Disconnect the pump and other components from the electrical supply to prevent accidental operation.



WARNING:

The pump may be contaminated with the process chemicals that have been pumped during operation. If so, ensure that the pump is decontaminated before maintenance and take correct precautions to protect people from the effects of dangerous substances if contamination has occurred.



WARNING:

Do not touch or inhale the thermal breakdown products of fluorinated materials which may be present in the pump if the pump has been heated to 260 °C and above. Fluorinated materials are safe in normal use but can decompose into very dangerous substances (which may include hydrofluoric acid) if heated to 260 °C and above. The pump may have overheated if it was misused or if it was in a fire. Safety Data Sheets for fluorinated materials used in the pump are available on request; contact us or the supplier.



CAUTION:

External surfaces of the pump should be cleaned using a damp cloth. Care must be taken with solvent-based cleaning fluids as they may remove important information from the product labels.

The pump is designed to require little user maintenance. Observe the following guidelines when carrying out maintenance on the pump:

- Ensure the maintenance is done by a suitably trained and supervised technician. Obey local and national safety requirements.
- Ensure the maintenance technician is familiar with the safety procedures which relate to the products processed by the pumping system.
- Check that all the required parts are available and are of the correct type before starting work.
- Isolate the pump and other components from the electrical supply to prevent accidental operation.
- Allow the pump to cool for at least 3 hours before starting maintenance work.

6.2 Maintenance plan

More frequent maintenance may be required if the pump is used to pump aggressive gases or vapours, such as solvents, organic substances and acids, or if the pump is operated continuously at the higher end of its operating temperature.

Table 14 Maintenance plan

Operation	Frequency (months)	Service indicator	Section reference
Inspect and clean the inlet strainer	12	No	Inspect and clean the inlet strainer on page 39
Inspect and clean the external fan cover if required	12	No	Clean the external fan cover on page 39
Check the pump performance	30	Yes	Check the pump performance (service indicator) on page 40
Replace the pump bearings	60	Yes	Replace the tip-seals on page 40
Replace the pump controller	120	Yes	Replace the tip-seals on page 40
Electrical safety check	60	No	Replace the pump controller (service indicator) on page 41

For service indicator codes, refer to [Service indicator codes on page 41](#).

6.3 Inspect and clean the inlet strainer

Whenever the pump is disconnected from the vacuum system, or on an annual basis, we recommend:

- Removing the inlet strainer from the pump inlet (refer to [Figure: nXDS scroll pump on page 11](#)) and remove any debris that may have accumulated.
- Inspecting the inlet strainer and if necessary, clean it with a cleaning solution suitable for the substances pumped. Refit the inlet strainer before reconnecting the pump to the vacuum system. Refer to [Connect to the vacuum system on page 28](#).

6.4 Clean the external fan cover

If the fan cover is not kept clean, the air flow over the pump can be restricted and the pump may overheat.

1. Switch off the pump and disconnect it from the electrical supply.
2. Use a dry cloth and a soft brush to remove dirt and deposits from the fan cover.

6.5 Check the pump performance (service indicator)

The service indicator, (flashing ON 1s / OFF 1s) is triggered as a reminder to check the performance of the pump. The service indicator will flash to indicate that a tip-seal change may be required (based on typical tip-seal life). If after checking, the pump is no longer achieving the required performance, we recommend you to replace a tip-seal (refer to [Service indicator codes on page 41](#)).

If the pump performance is within acceptable limits, or is performing satisfactorily, the tip-seal replacement can be delayed.

If operating a preventative maintenance plan, depending upon the particular regime, a tip-seal change can be carried out at this time irrespective of the pump performance.

To reset the service indicator, refer to [Service indicator codes on page 41](#).

6.6 Replace the tip-seals

This information is applicable to the nXDS replacement tip seal kit that must be fitted. Refer to [Tip-seal kit on page 52](#) for ordering information.

A tip-seal replacement should be carried out to maintain or restore the pumps performance. The frequency for replacing the pump tip-seals is determine by the following factors:

- The pump has reached a service interval. Refer to [Check the pump performance \(service indicator\) on page 40](#) and [Replace the pump bearings \(service indicator\) on page 40](#).
- The pump is no longer achieving the required performance.

If the pump is no longer achieving the required performance prior to a service interval being reached, we recommend you to follow the guide lines, refer to [The pump has failed to achieve the required performance on page 43](#).

Note:

There may be a running-in period after fitting your new tip-seals. The performance should improve over a period of 24 to 48 hours. If the pump performance does not improve sufficiently after the running-in period, please contact us for advice.

For information on how to replace the nXDS tip-seals and Health and Safety, refer to the nXDS replacement tip seal kit instruction manual A73502840 which is included on the CD manual. Also refer to Youtube video at <https://www.youtube.com/watch?v=vKnh9dxOyhE>.

6.7 Replace the pump bearings (service indicator)

The service indicator, (flashing ON 3s / OFF 1s) is triggered to indicate that a bearing replacement service interval has been reached. Bearing wear cannot necessarily be detected under normal operating conditions. This service interval is a recommendation that a bearing replacement is required, this is especially useful if operating a preventative maintenance plan.

It is possible for an experienced technician, who is suitably trained, to perform maintenance and repair on nXDS pumps up to and including bearing replacement. We have developed a detailed maintenance manual and instructional video (part number A73501713) that will enable an experienced technician to undertake this work. If required, we can also provide face to face training. Please contact us for more information or to purchase this training.

 **Note:**

Failure to replace the pump bearings at this time may subsequently lead to damage of the pumping mechanism.

A tip-seal change and exhaust and ballast valve change should be carried out at the same time when performing a bearing replacement. Refer to [Spares on page 52](#) for ordering information.

To reset the service indicator, refer to [Service indicator codes on page 41](#).

6.8 Replace the pump controller (service indicator)

The service indicator, (flashing ON 3s / OFF 3s) is triggered to indicate that the pump controller should be replaced. Contact us for further details.

To reset the service indicator, refer to [Service indicator codes on page 41](#).

6.9 Electrical safety check

Test the earth continuity and the insulation resistance of the pump system in accordance with local regulations for the periodic testing of electrical equipment.

The earth continuity should be less than 0.1 Ω and the DC insulation resistance greater than 1.0 M Ω .

If the pump fails any of these tests, contact us or the supplier.

6.10 Service indicator codes

The nXDS controller incorporates a service indicator (refer to [Figure: LED indicators on page 23](#)). The service indicator will flash a specific code whenever a service interval has been reached. There are three service levels listed in [Table: Flashing service codes on page 41](#).

Table 15 Flashing service codes

Service flash code	Comments	See section
ON 1s / OFF 1s	Pump performance check.	Check the pump performance (service indicator) on page 40
ON 3s / OFF 1s	Pump bearing service.	Replace the tip-seals on page 40
ON 3s / OFF 3s	Pump-Controller service.	Replace the pump bearings (service indicator) on page 40

To reset the service indicator, press and hold the standby speed increase and decrease buttons simultaneously for more than 5 seconds.

 **Note:**

Resetting the pump bearing service indicator will also reset the performance check timer, that is, both counters will be set to zero.

Resetting the service indicator will reset the service timer back to zero (refer to [Table: Maintenance plan on page 39](#)).

7. Fault finding

7.1 The pump has failed to start or has stopped

- The electrical supply fuse has blown.
- The ambient temperature is too high.
- The cooling air supply is insufficient or is too hot.
- The process gas is too hot or the throughput is too high.
- The fan is not working or is not connected.
- The motor is faulty.

7.2 The pump has failed to achieve the required performance

- Gas ballast may be selected. To close gas ballast, turn the control a quarter turn so that the valve snaps shut. Use this setting to achieve the best possible vacuum. If the pump has been used to pump condensable vapours or is to pump a large chamber that has been exposed to atmospheric air (water vapour), it may be necessary to run for at least an hour on gas ballast.
- If the electrical supply voltage is more than 10% below the lowest voltage specified on the user interface panel, the pump may operate but deliver a degraded vacuum performance.
- There is a leak in the system.
- Tip seals may need further run-in, typically 24 hours, with some requiring up to a maximum of 100 hours.
- The pressure measurement technique or gauge head is unsuitable or gives an incorrect indication of pressure.
- The vacuum fittings are dirty or damaged. Replace the fittings.
- The inlet strainer is blocked. Clean or replace the strainer.
- The connecting pipelines are too long or too small in diameter, conductance.
- There is high pressure or a blockage in the exhaust line.
- The pump contains traces of process vapours, Run 12 hours with gas ballast.
- The pump is outside the specified range of operating conditions.
- The tip seals need replacing.
- The pump is in standby mode.

7.3 The pump has poor ultimate vacuum

If the pump exhibits poor ultimate vacuum, refer to [Figure: Poor ultimate vacuum flow chart on page 44](#).

Figure 13 Poor ultimate vacuum flow chart

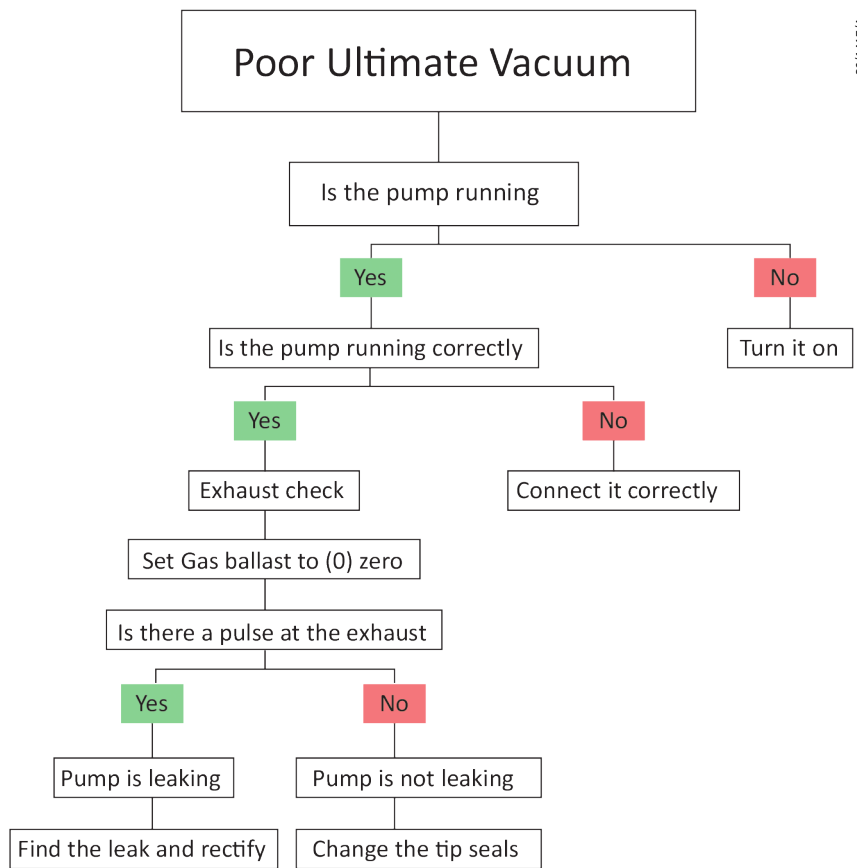

CS/1417/A

7.4 The pump is noisy

If the pump is noisy, refer to [Figure: Noisy pump flow chart on page 45](#).

Figure 14 Noisy pump flow chart

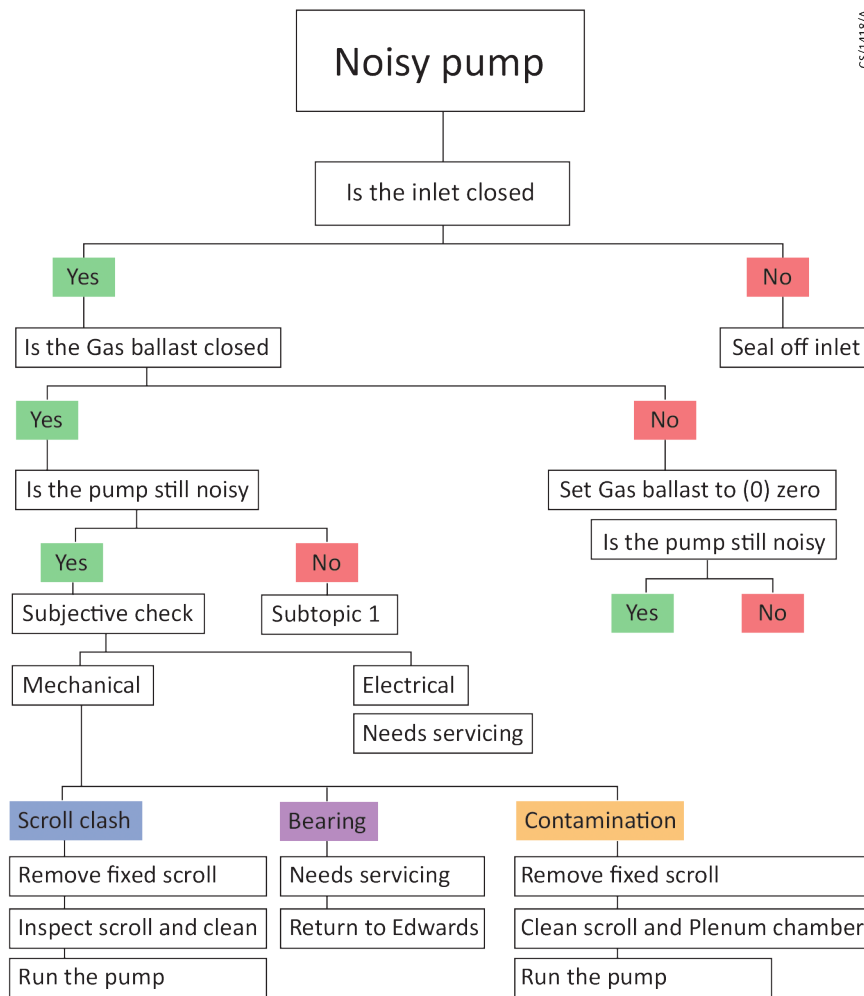

7.5 The pump surface temperature is high

- The ambient temperature is too high.
- The cooling fan is not running.
- The process gas is too hot or the maximum continuous operating pressure has been exceeded.

7.6 Alarm indicator codes

Whenever a fail condition becomes active the red alarm indicator shows a flashing sequence. If the error light is on continuously this indicates a problem has been found with the embedded software. In this case, try cycling the power. If cycling the power does not clear the indication, a software download may be required. In this situation, contact us or the supplier. If the alarm indicator is flashing, identify the error flash code and consult [Table: Flashing error codes on page 46](#).

There is a sufficient off period between each subsequent cycle repetition to clearly mark the start of a new flash sequence. The duration of a long flash (L) is equal to 3 times the duration of a short flash (0.5 s).

Table 16 Flashing error codes

Error flash position	Error flash sequence	Comment	Actions
0	ssssss	Overload timeout.	Check whether the pump is not running under constant high pressure or the inlet or outlet is not blocked.
1	Lsssss	Controller software error.	Cycle the power to the pump and see whether the error code appears again. If it does, contact us or the supplier.
2	sLssss	Controller failed internal configuration and calibration operation.	Cycle the power to the pump and see whether the error code appears again. If it does, contact us or the supplier.
3	ssLsss	Acceleration timeout.	Check whether the pump is not running under constant high pressure or the inlet or outlet is not blocked.
4	sssLss	Over-current trip activated, or other hardware fault.	Cycle the power to the pump and see whether the error code appears again. If it does, contact us or the supplier.
5	ssssLs	Self test fault.	Cycle the power to the pump and see whether the error code appears again. If it does, contact us or the supplier.
6	sssssL	Serial Control Mode Interlock.	Re-activate serial enable and send a serial command to clear the error code.

8. Storage and disposal

8.1 Storage

Use the following procedure to store the pump:

1. Shut down the pump as described in [Shut down on page 36](#).
2. Disconnect the pump from the electrical supply.
3. Place and secure protective covers over the inlet and outlet ports.
4. Store the pump in cool, dry conditions until required for use. When required, prepare and install the pump as described in [Installation on page 25](#).

8.2 Disposal

Dispose of the pump and any components from it safely in accordance with all local and national safety and environmental requirements.

Particular care must be taken with components which have been contaminated with dangerous process substances.

Do not incinerate fluoroelastomer seals and O-rings.

9. Spares and accessories

9.1 Introduction

Our products, spares and accessories are available from our companies in Belgium, Brazil, China, France, Germany, Israel, Italy, Japan, Korea, Singapore, United Kingdom, U.S.A and a world-wide network of distributors. The majority of these centres employ Service Engineers who have undergone our comprehensive training courses.

Order spare parts and accessories from our nearest company or distributor. When ordering, state for each part required:

- Model and item number of your equipment
- Serial number
- Item number and description of part

9.2 Accessories

Figure 15 nXDS accessories

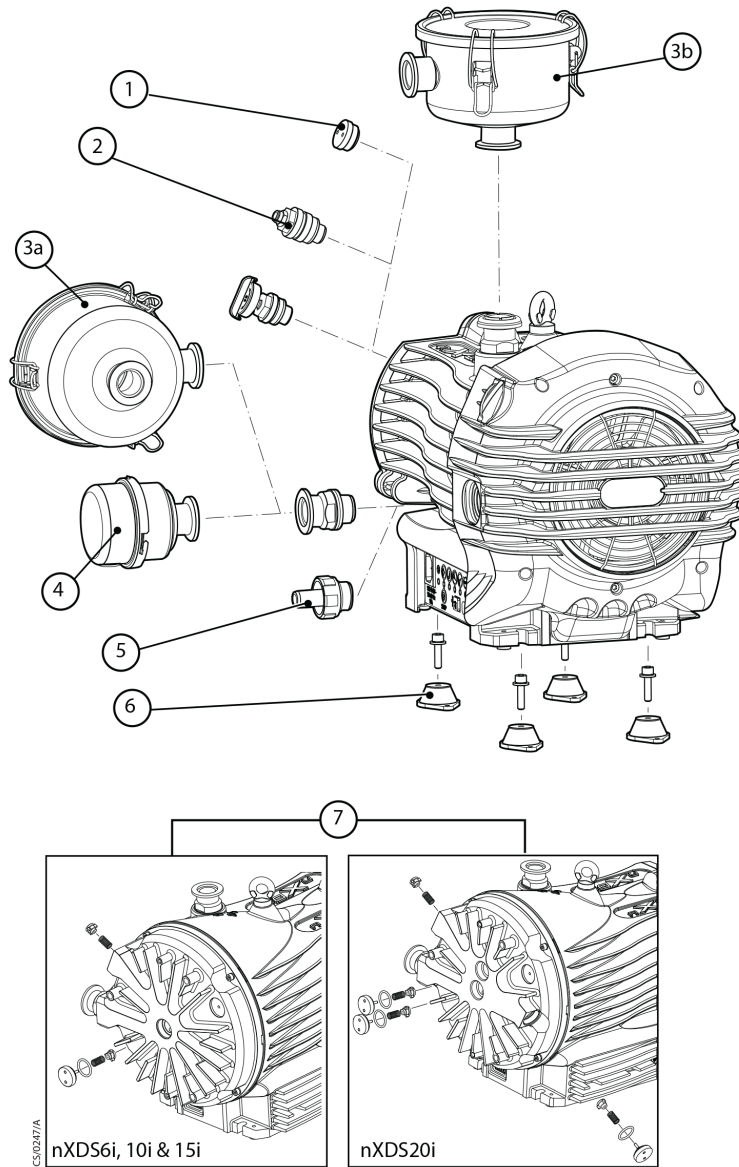

- | | |
|---------------------------------------|---|
| 1. Gas ballast adaptor blank | 2. Gas ballast adaptor |
| 3. 3a+3b Inlet/exhaust filter | 4. Silencer |
| 5. Exhaust nozzle | 6. Vibration isolators |
| 7. Chemical resistance conversion kit | 8. Pump-to-controller cable (not shown) |

9.2.1 Silencer

A silencer is available for the nXDS pump. Refer to [Connect to the vacuum system on page 28](#) for guidance on its use.

Table 17 Silencer

Product description	Ordering information
Silencer NW25	A50597000

9.2.2 Gas ballast adaptor

A gas ballast adaptor may be fitted in place of the gas ballast control on the pump. The adaptor allows a controlled supply of inert gas to be connected to the pump.

Gas ballast adaptor

Product description	Ordering information
Gas ballast adaptor with fine restrictor	A73501809
Gas ballast adaptor without fine restrictor	A73501811

9.2.3 Gas ballast adaptor blank

This adaptor kit allows the conversion of a standard nXDS pump into an nXDS-R version. The gas ballast control is replaced with a blank adaptor so that the gas ballast cannot be accidentally opened. This feature is useful for applications such as rare gas recirculation or gas recovery. Another advantage is improved leak tightness at this location.

Table 18 Gas ballast blank adaptor

Product description	Ordering information
Gas ballast blank adaptor	A73501806

9.2.4 Vibration isolators

Fit vibration isolators to the pump to reduce the transmitted vibration from the pump to a structure, such as a frame or a system.

Table 19 Vibration isolators

Product description	Ordering information
Vibration isolators (pack of 4)	A24801441

9.2.5 Inlet/exhaust filter

The inlet dust filter has two functions. It can be connected inline between the pump inlet and your chamber outlet connection to prevent dust from migrating into your system. Alternatively, it can be connected inline between the pump exhaust and your exhaust extraction system. The filter is supplied ready to use with a 5 µm element.

Note:

If connecting the exhaust filter onto the pump outlet, an NW25 / hose nozzle, C10514328 is available to connect onto the outlet of the dust filter.

Table 20 Inlet/exhaust filter

Product description	Ordering information
Inlet/exhaust filter NW25/NW25	A50597805

9.2.6 Exhaust nozzle

The exhaust nozzle screws into the outlet flange. Use the exhaust nozzle to connect the pump to the 12 mm internal diameter plastic hose.

Table 21 Exhaust nozzle

Product description	Ordering information
Exhaust nozzle	A50509000

9.2.7 Chemical resistance conversion kit

This adaptor kit allows a standard nXDS pump to be converted into an nXDS-C version. This conversion may be necessary if the pump is used on applications involving corrosive substances. For more information, contact us.

Note:

If returning the pump to us for repair or service having been converted from a standard version to an nXDS-C version, our service must be informed, otherwise the pump will be returned back as a standard version.

Table 22 Chemical resistance conversion kit

Product description	Ordering information
Chemical adaptor kit for nXDS 6i, 10i or 15i	A73501807
Chemical adaptor kit for nXDS20i	A73501808

9.2.8 Electrical cables

Refer to [Table: Electrical cables on page 51](#). The following electrical cables are available as accessories and should be used to connect the nXDS pump to the electrical supply.

Table 23 Electrical cables

Product description	Ordering information
Lead Assembly, 10 A, C13, UK	A50505000
Lead Assembly, 10 A, C13, Europe	A50506000
Lead Assembly, 10 A, C13, USA	A50507000
Lead Assembly, 10 A, C13, No Plug	A50508000

9.2.9 Pump-to-controller cable

Use the control cable to control the nXDS pump using Turbo Instrument Controller (TIC) or TIC Turbo Controller, or a (TAG) Turbo and Active Gauge controller.

Table 24 Pump-to-controller cables

Product description	Ordering information
1 m cable	D39700835
2 m cable	D39700836
5 m cable	D39700837

9.3 Spares

9.3.1 Tip-seal kit

Used to maintain or restore the performance of the pump. Refer to [Service indicator codes on page 41](#).

Table 25 Tip-seal kit

Product description	Ordering information
Tip-seal kit	A73501801

9.3.2 Cooling fan

Used to replace the cooling fan located inside the nXDS fan cowl. Refer to [Figure: nXDS scroll pump on page 11](#), item 4.

Table 26 Cooling fan

Product description	Ordering information
Cooling fan	A73501707

9.3.3 Gas ballast knob

Replacement gas ballast control knob attached to the gas ballast control. Refer to [Figure: nXDS scroll pump on page 11](#), item 3.

Table 27 Gas ballast knob

Product description	Ordering information
Gas ballast control knob	A73501059

9.3.4 Silencer spares kit

Replacement spares for the nXDS silencer A50597000.

Table 28 Silencer spares kit

Product description	Ordering information
Silencer spares kit	A50597800

9.3.5 Inlet/exhaust filter spares

Replacement elements for the inlet/exhaust filter A50597805.

Table 29 *Inlet/exhaust filter spares*

Product description	Ordering information
5 micron element	A50597802
1 micron element	A50597803

9.3.6 Bearing replacement kit (not field serviceable)

Used when the pump has reached a long run service interval. Specific training is required to replace the bearings on nXDS pumps. See [Replace the pump bearings \(service indicator\) on page 40](#) for details of our options for providing this training.

Table 30 *Bearing replacement kit*

Product description	Ordering information
Bearing replacement kit	A73501802

9.3.7 Exhaust and ballast valve kit

Used when the pump has reached a long run service interval.

Table 31 *Exhaust and ballast valve kit*

Product description	Ordering information
Exhaust and ballast valve kit (standard and R versions)	A73501803
Exhaust and ballast valve kit (C versions only)	A73501804

 **Note:**

nXDS20i, nXDS20iR and nXDS20iC versions require two service kits per pump.

10. Service

10.1 Return the equipment or components for service

Before you send your equipment to us for service or for any other reason, you must send us a completed Declaration of Contamination of Vacuum Equipment and Components – Form HS2. The HS2 form tells us if any substances found in the equipment are hazardous, which is important for the safety of our employees and all other people involved in the service of your equipment. The hazard information also lets us select the correct procedures to service your equipment.

We provide instructions for completing the form in the Declaration of Contamination of Vacuum equipment and Components – Procedure HS1.

If you are returning a vacuum pump, note the following:

- If a pump is configured to suit the application, make a record of the configuration before returning the pump. All replacement pumps will be supplied with default factory settings.
- Do not return a pump with accessories fitted. Remove all accessories and retain them for future use.
- The instruction in the returns procedure to drain all fluids does not apply to the lubricant in pump oil reservoirs.

Download the latest documents from www.edwardsvacuum.com/HSForms/, follow the procedure in HS1, fill in the electronic HS2 form, print it, sign it, and return the signed copy to us.



NOTICE:

If we do not receive a completed HS2 form, your equipment cannot be serviced.

